

Article number: 0106065

Description: Retaining ring JV 48

Measures

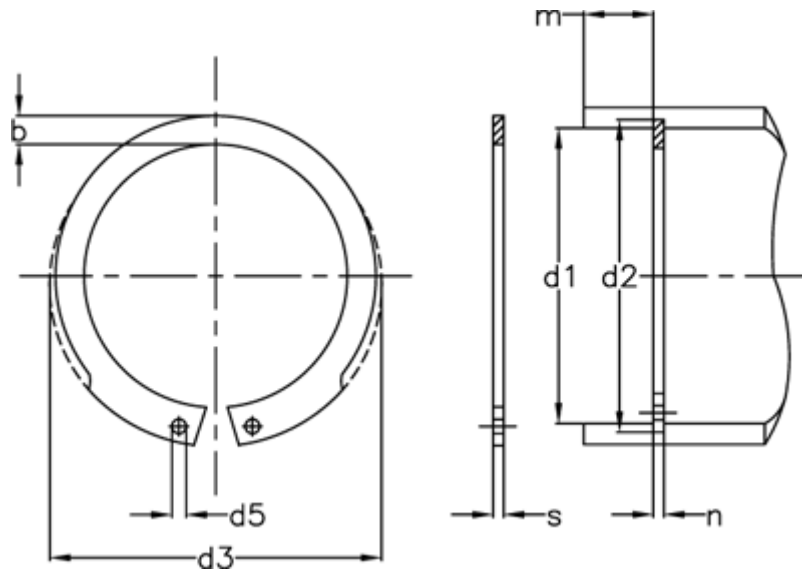

AN mm ²	= 96	FRg kN	= 9.1	tol	= 0.2
b	= 4.7	FR kN	= 48.0	tol	= -0.06
d1	= 48	g	= 2.0	tol	= +1,10-0,46
d2	= 50.5	K kN-mm	= 85.8	tol	= +0,30
d3	= 51.5	m min	= 1.85	Tong	= ZGJ-2
d5 min	= 2.0	Nominal drive	= 4.5	Weight kg/1000	= 7.00
Description	= JV 48	s	= 1.75		
FN kN	= 16.00	t	= 1.25		